

OSRAM SFH 7017

Datasheet

Published by **ams-OSRAM AG**

Tobelbader Strasse 30, 8141 Premstaetten, Austria

Phone +43 3136 500-0

ams-osram.com

© All rights reserved



Multi Chip LED

SFH 7017

2x Green (530 nm), 1x Red (655 nm) and
1x Infrared (940 nm) Emitter

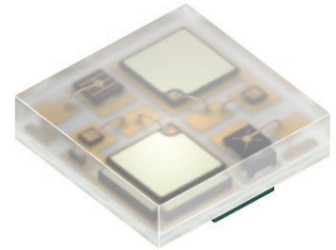

Applications

- Health Monitoring (Heart Rate Monitoring, Pulse Oximetry)

Features

- Package: diffuse silicone
- ESD: 2 kV acc. to ANSI/ESDA/JEDEC JS-001 (HBM, Class 2)
- SMT package
- Suitable for SMT assembly
- Available on tape and reel
- Emitters can be controlled separately

Ordering Information

Type	Brightness ¹⁾²⁾	Ordering Code
SFH 7017		Q65113A3761
● green	● $I_e = 2.20 \dots 5.40 \text{ mW/sr}$ ($I_F = 20 \text{ mA}$)	
● hyper red	● $I_e = 2.50 \dots 7.00 \text{ mW/sr}$ ($I_F = 20 \text{ mA}$)	
● infrared (940 nm)	● $I_e = 1.65 \dots 4.05 \text{ mW/sr}$ ($I_F = 20 \text{ mA}$)	

Maximum Ratings

$T_s = 25\text{ °C}$

Parameter	Symbol		Values	Values	Values
			● green	● hyper red	● infrared (940 nm)
Operating temperature	T_{op}	min.	-40 °C	-40 °C	-40 °C
		max.	85 °C	85 °C	85 °C
Storage temperature	T_{stg}	min.	-40 °C	-40 °C	-40 °C
		max.	85 °C	85 °C	85 °C
Junction temperature	T_j	max.	100 °C	100 °C	100 °C
Forward current	I_F	max.	30 mA	40 mA	60 mA
Forward current pulsed $t_p \leq 2\ \mu\text{s}$ (green); $t_p \leq 120\ \mu\text{s}$ (red); $t_p \leq 20\ \mu\text{s}$ (IR); $D \leq 0.005$	$I_{F\ pulse}$	max.	0.75 A	0.3 A	1 A
Reverse voltage ³⁾	V_R	max.	5 V	5 V	5 V
Power consumption	P_{tot}	max.	90 mW	120 mW	110 mW
ESD withstand voltage acc. to ANSI/ESDA/JEDEC JS-001 (HBM, Class 2)	V_{ESD}	max.	2 kV	2 kV	2 kV

The stated maximum ratings refer to one chip, unless otherwise specified.

Characteristics

$I_F = 20 \text{ mA}$; $t_p = 20 \text{ ms}$; $T_s = 25 \text{ °C}$

Parameter	Symbol		Values	Values	Values
			● green	● hyper red	● infrared (940 nm)
Peak wavelength	λ_{peak}	typ.	526 nm	660 nm	950 nm
Centroid wavelength ⁴⁾	$\lambda_{\text{centroid}}$	min.	523 nm	653 nm	931 nm
		typ.	530 nm	656 nm	940 nm
		max.	542 nm	658 nm	950 nm
Spectral bandwidth at 50% $I_{\text{rel,max}}$ (FWHM)	$\Delta\lambda$	typ.	27 nm	17 nm	42 nm
Half angle	φ	typ.	60 °	60 °	60 °
Dimensions of active chip area	L x W	typ.	0.75 x 0.75 mm x mm	0.3 x 0.3 mm x mm	0.3 x 0.3 mm x mm
Rise time (10% / 90%) $I_F = 20 \text{ mA}$; $R_L = 50 \text{ } \Omega$	t_r	typ.	155 ns	17 ns	16 ns
Fall time (10% / 90%) $I_F = 20 \text{ mA}$; $R_L = 50 \text{ } \Omega$	t_f	typ.	260 ns	17 ns	16 ns
Forward voltage ⁵⁾	V_F	typ.	2.3 V	1.9 V	1.3 V
		max.	2.8 V	2.4 V	1.5 V
Radiant intensity ¹⁾²⁾ $I_F = 20 \text{ mA}$; $t_p = 20 \text{ ms}$	I_e	min.	2.2 mW/sr	2.5 mW/sr	1.65 mW/sr
		typ.	4.3 mW/sr	4.2 mW/sr	3.1 mW/sr
		max.	5.4 mW/sr	7 mW/sr	4.05 mW/sr
Total radiant flux ⁶⁾	Φ_e	typ.	14 mW	13 mW	10 mW
Temperature coefficient of voltage	TC_V	typ.	-1 mV / K	-1.7 mV / K	-0.8 mV / K
Temperature coefficient of brightness	TC_I	typ.	-0.2 % / K	-0.7 % / K	-0.3 % / K
Temperature coefficient of wave-length	TC_λ	typ.	0.06 nm / K	0.18 nm / K	0.3 nm / K
Thermal resistance junction solder point real ⁷⁾	$R_{\text{thJS real}}$	typ.	25 K / W	170 K / W	190 K / W
		max.	36 K / W	200 K / W	220 K / W

Relative Spectral Emission 8), 9)

- green: $I_{e,rel} = f(\lambda)$; $I_F = 20 \text{ mA}$; $t_p = 20 \text{ ms}$

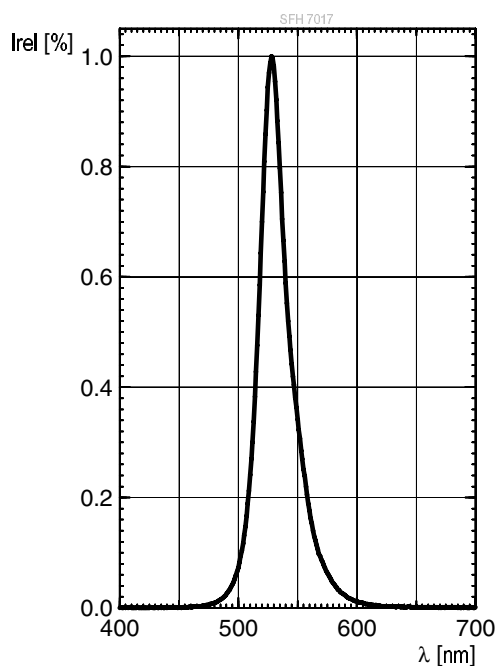

Relative Spectral Emission 8), 9)

- hyper red: $I_{e,rel} = f(\lambda)$; $I_F = 20 \text{ mA}$; $t_p = 20 \text{ ms}$

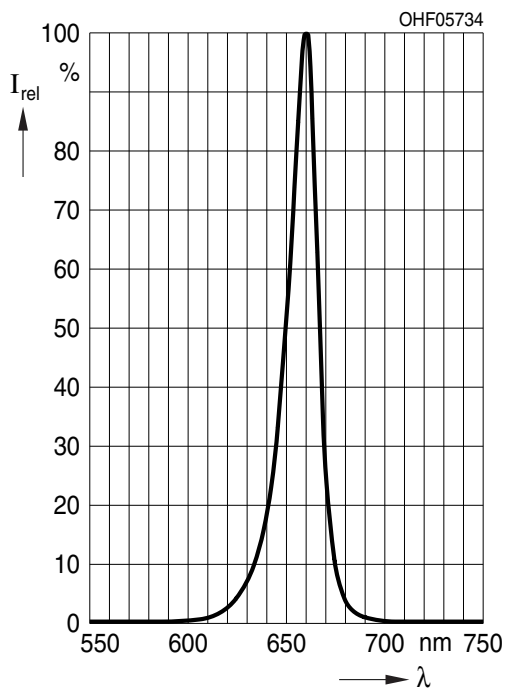

Relative Spectral Emission ^{8), 9)}

- infrared (940 nm): $I_{e,rel} = f(\lambda)$; $I_F = 20 \text{ mA}$; $t_p = 20 \text{ ms}$

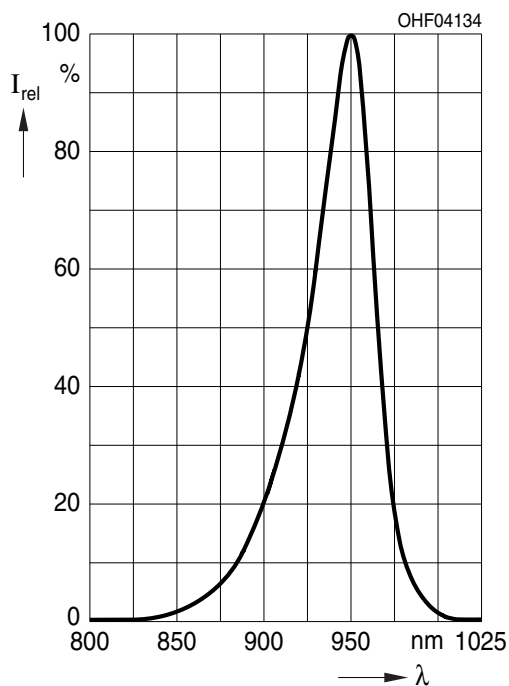

Radiation Characteristics ^{8), 9)}

- green/ red/ infrared: $I_{rel} = f(\phi)$

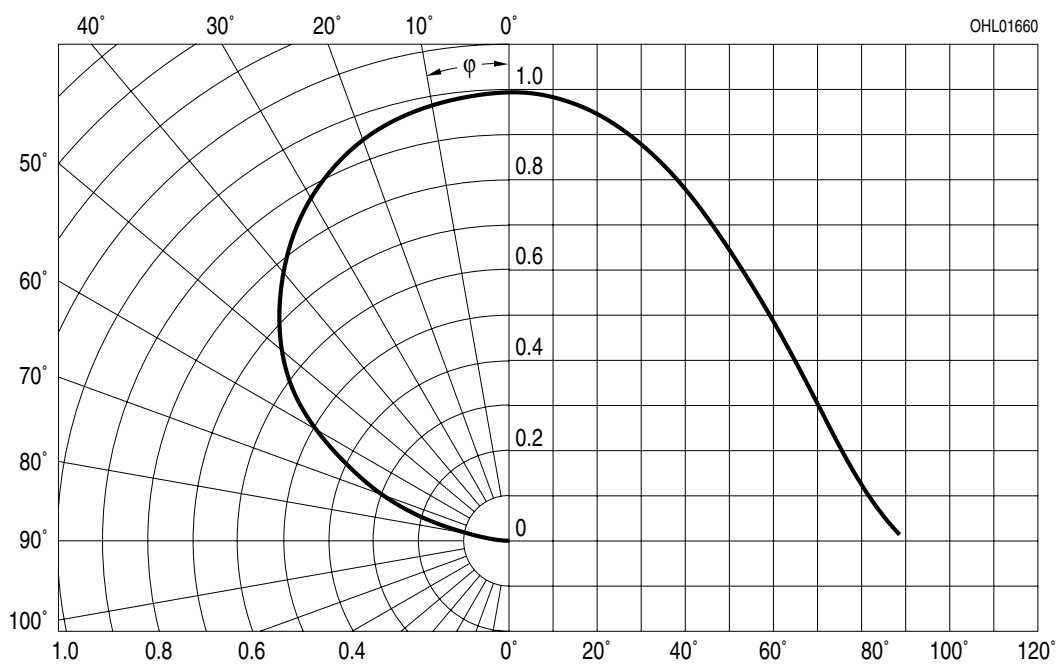

Forward current 8), 9)

- green: $I_F = f(V_F)$; single pulse; $t_p = 100 \mu s$

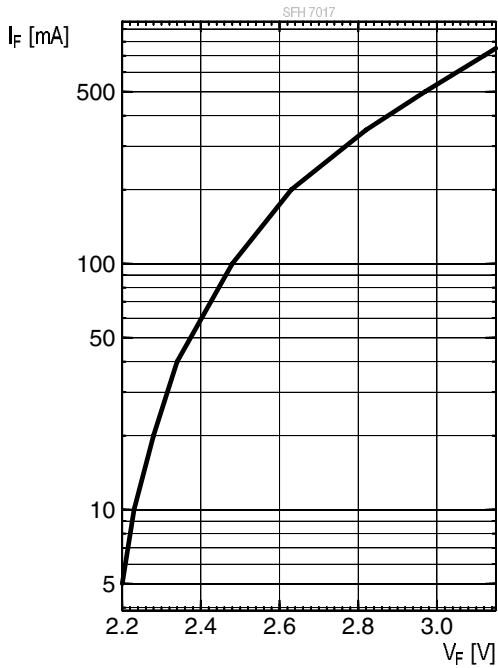

Forward current 8), 9)

- hyper red: $I_F = f(V_F)$; single pulse; $t_p = 100 \mu s$

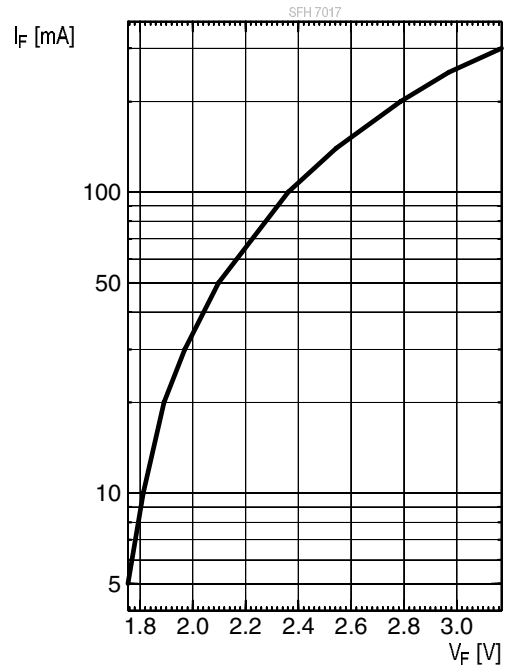

Forward current 8), 9)

- infrared (940 nm): $I_F = f(V_F)$; single p; $t_p = 100 \mu s$

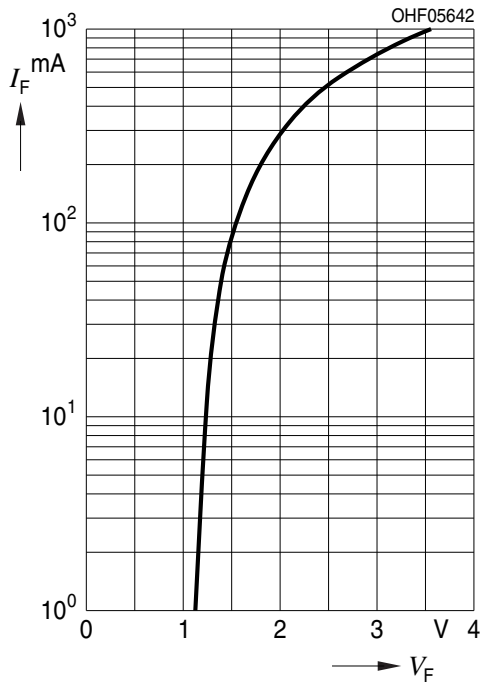

Relative Radiant Intensity ^{8), 9)}

- green: $I_e/I_e(20\text{mA}) = f(I_F)$; single pulse; $t_p = 100 \mu\text{s}$

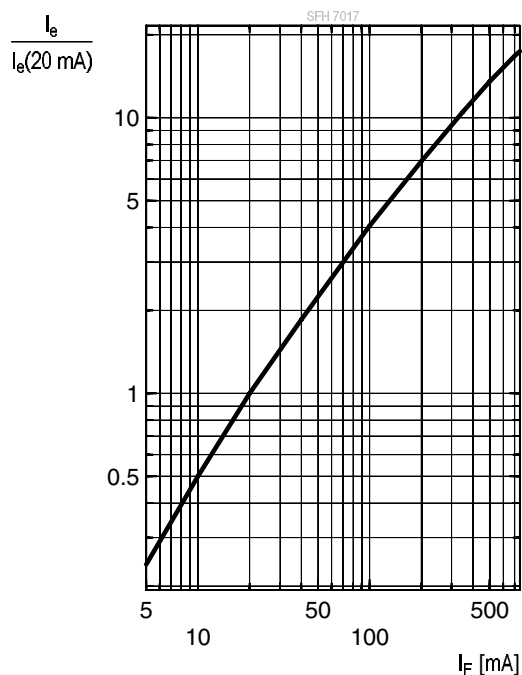

Relative Radiant Intensity ^{8), 9)}

- hyper red: $I_e/I_e(20\text{mA}) = f(I_F)$; single pulse; $t_p = 100 \mu\text{s}$

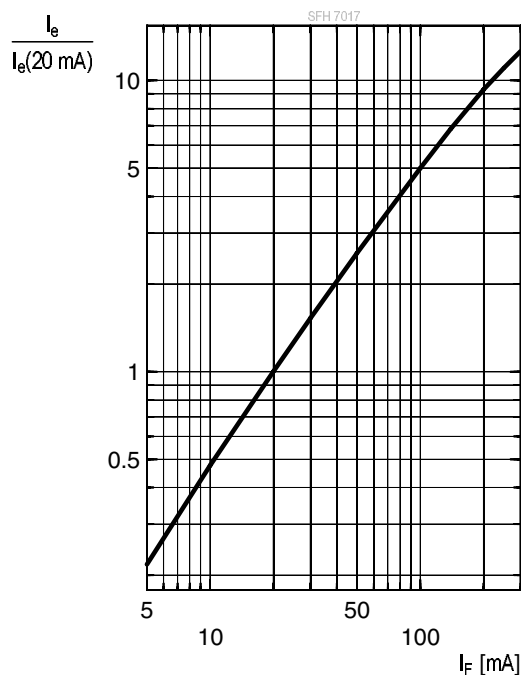

Relative Radiant Intensity ^{8), 9)}

- infrared (940 nm): $I_e/I_e(20\text{mA}) = f(I_F)$; s.p.; $t_p = 100 \mu\text{s}$

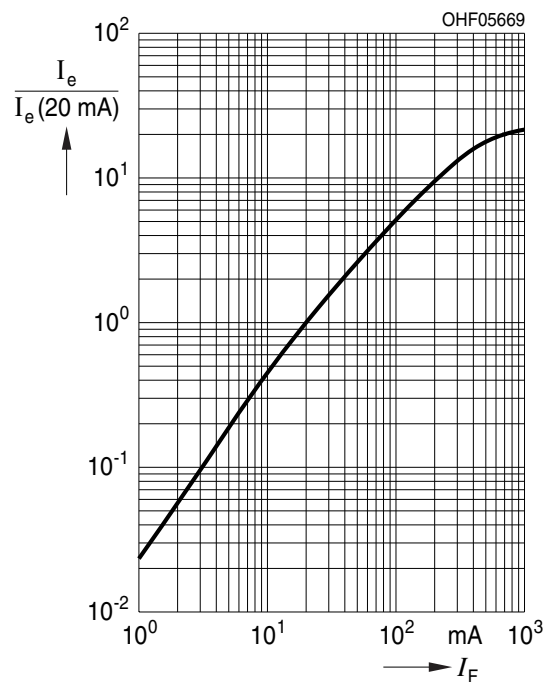

Max. Permissible Forward Current

- green: $I_F = f(T_S)$; $R_{th_{js}} = 36K / W$

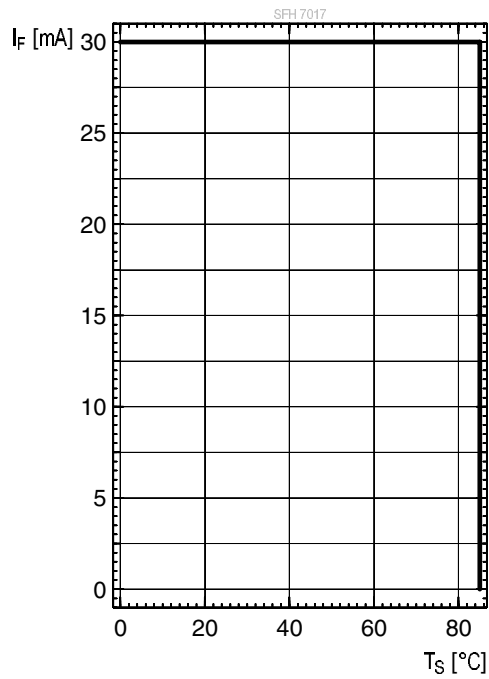

Max. Permissible Forward Current

- hyper red: $I_F = f(T_S)$; $R_{th_{js}} = 204K / W$

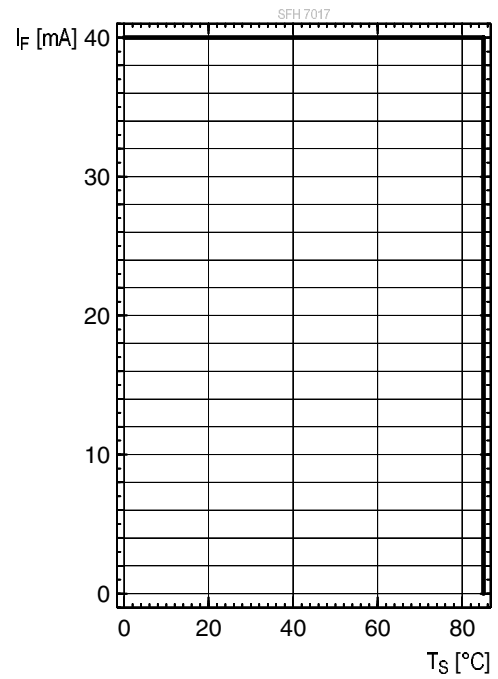

Max. Permissible Forward Current

- infrared (940 nm): $I_F = f(T_S)$; $R_{th_{js}} = 222K / W$

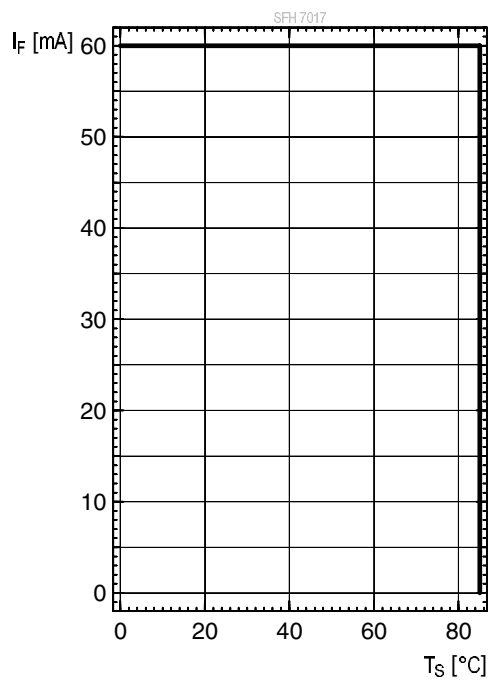

Permissible Pulse Handling Capability

• green: $I_F = f(t_p)$; $D = \text{parameter}$; $T_S = 85^\circ\text{C}$

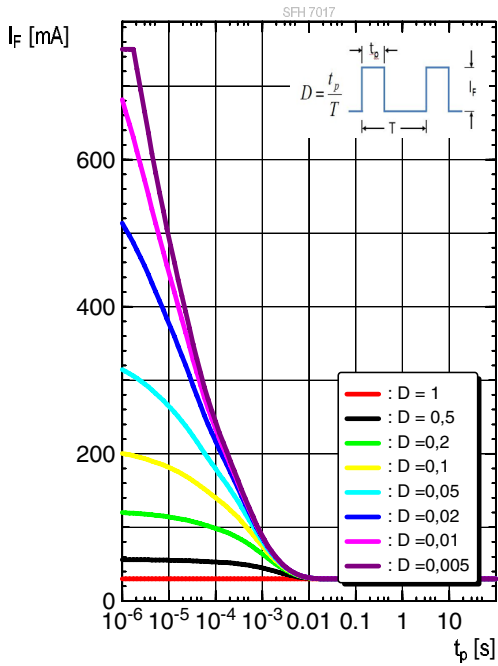

Permissible Pulse Handling Capability

• hyper red: $I_F = f(t_p)$; $D = \text{parameter}$; $T_S = 85^\circ\text{C}$

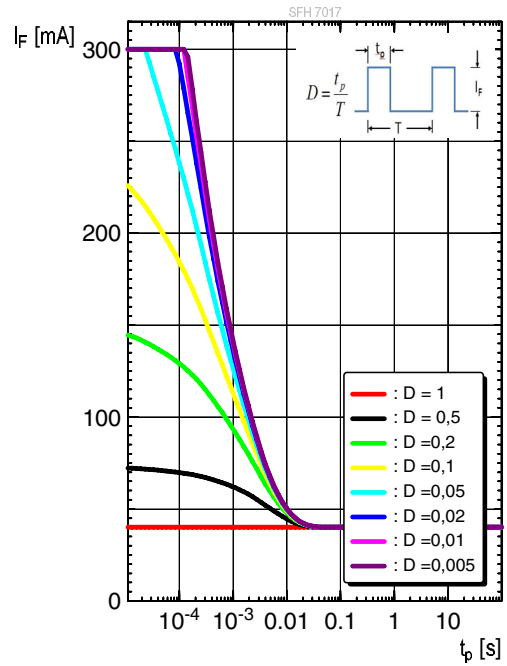

Permissible Pulse Handling Capability

• infrared (940 nm): $I_F = f(t_p)$; $D = \text{parameter}$; $T_S = 85^\circ\text{C}$

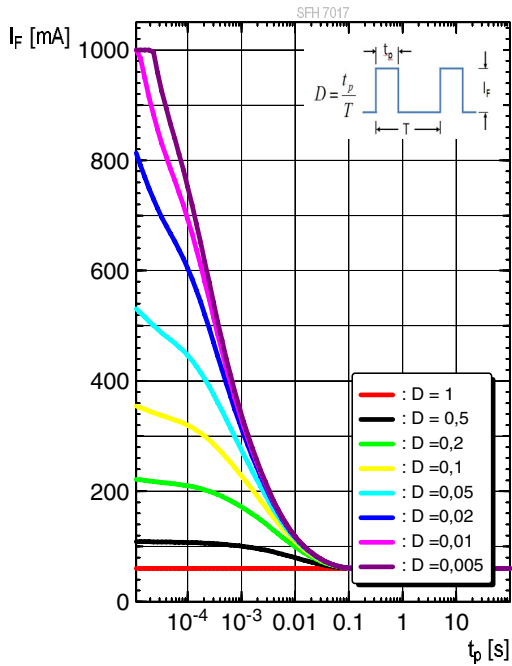

Dimensional Drawing ¹⁰⁾

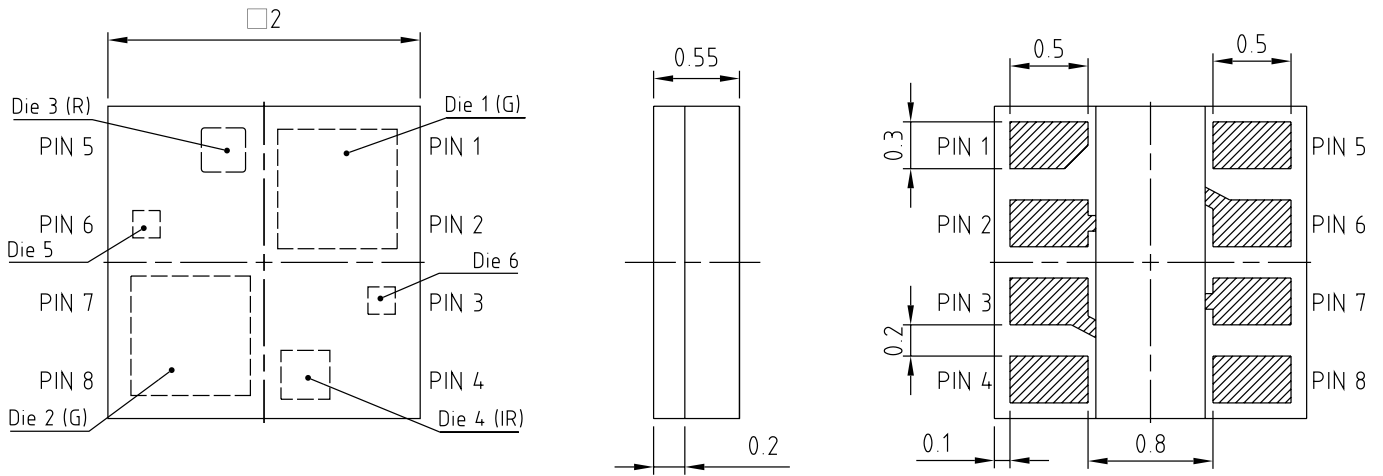

general tolerance ± 0.1
lead finish Au

C67062-A0337-A1-05

Further Information:

Approximate Weight: 3.0 mg

Pin	Description
1	Cathode - green 1
2	Anode - green 1
3	Anode - infrared
4	Cathode - infrared
5	Cathode - red
6	Anode - red
7	Anode - green 2
8	Cathode - green 2

Recommended Solder Pad ¹⁰⁾

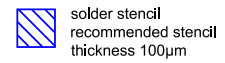
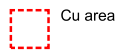
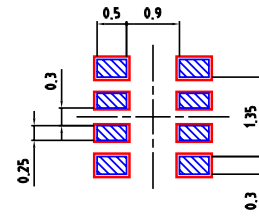
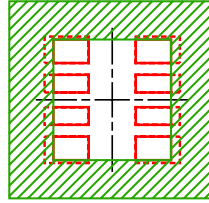
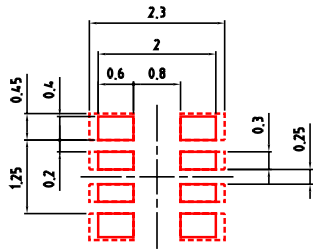

Component Location on Pad

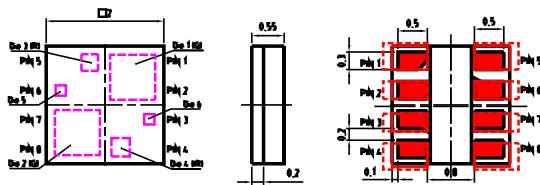

E062.3010.310 -01

Reflow Soldering Profile

Product complies to MSL Level 3 acc. to JEDEC J-STD-020E

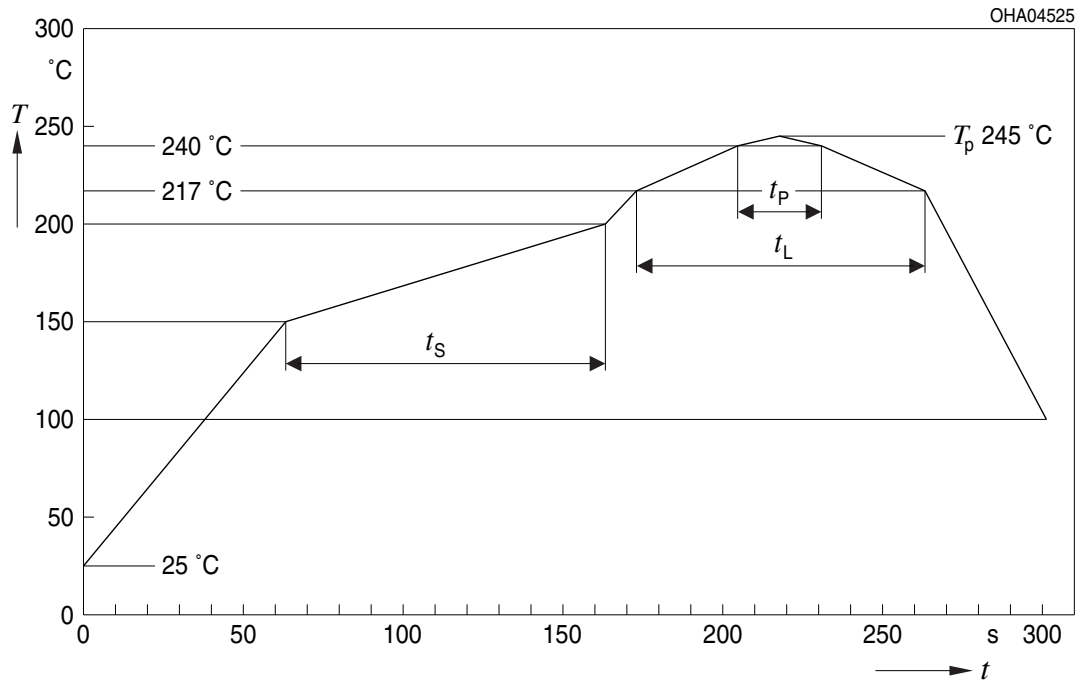

Profile Feature	Symbol	Pb-Free (SnAgCu) Assembly			Unit
		Minimum	Recommendation	Maximum	
Ramp-up rate to preheat ^{*)} 25 °C to 150 °C			2	3	K/s
Time t_s T_{Smin} to T_{Smax}	t_s	60	100	120	s
Ramp-up rate to peak ^{*)} T_{Smax} to T_p			2	3	K/s
Liquidus temperature	T_L		217		°C
Time above liquidus temperature	t_L		80	100	s
Peak temperature	T_p		245	260	°C
Time within 5 °C of the specified peak temperature $T_p - 5$ K	t_p	10	20	30	s
Ramp-down rate* T_p to 100 °C			3	6	K/s
Time 25 °C to T_p				480	s

All temperatures refer to the center of the package, measured on the top of the component
^{*} slope calculation DT/Dt : Dt max. 5 s; fulfillment for the whole T-range

Taping ¹⁰⁾

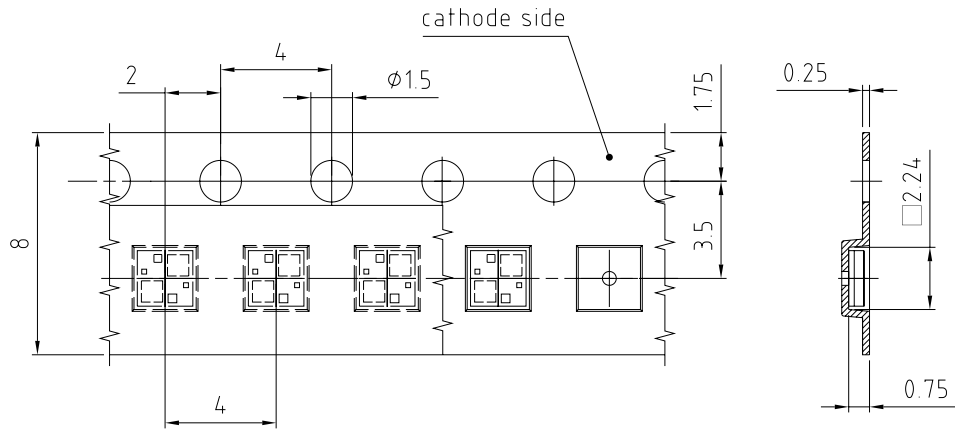

C67062-A0337-B1-05

Tape and Reel ¹¹⁾

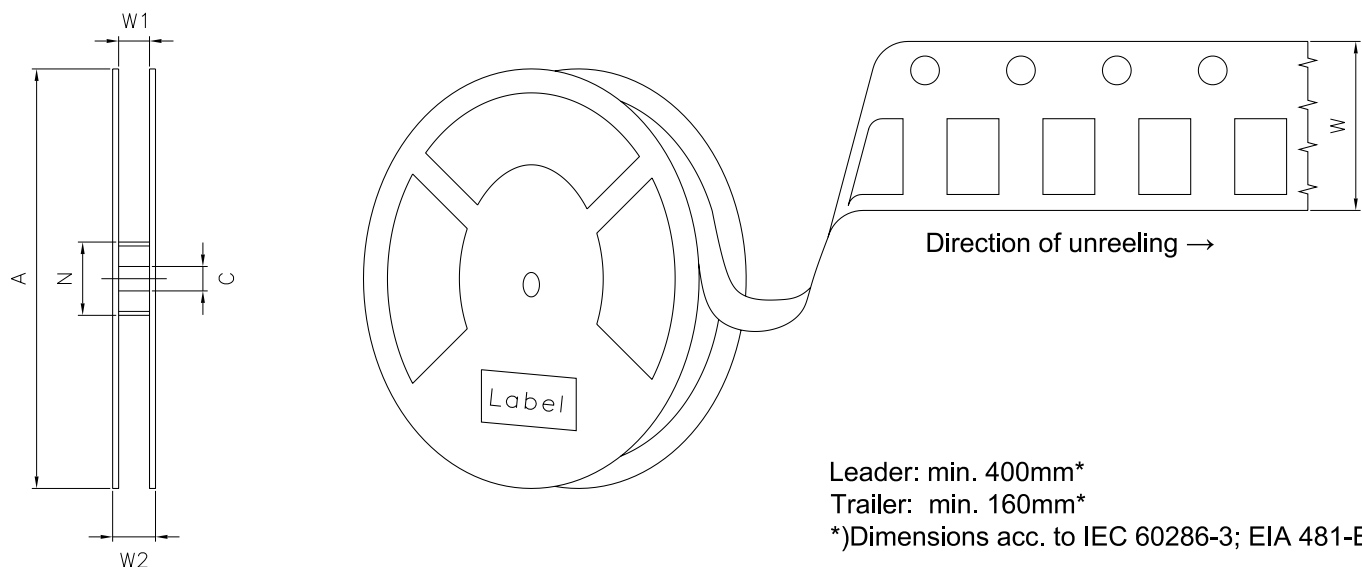

Reel Dimensions

A	W	N_{\min}	W_1	$W_{2\max}$	Pieces per PU
180 mm	$8 + 0.3 / - 0.1$ mm	60 mm	$8.4 + 2$ mm	14.4 mm	3000

Barcode-Product-Label (BPL)

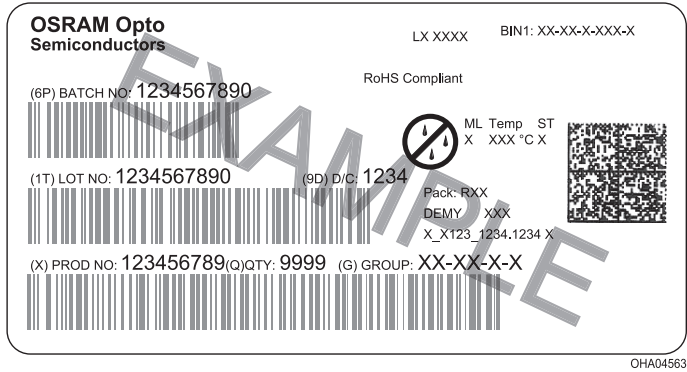

Dry Packing Process and Materials ¹⁰⁾

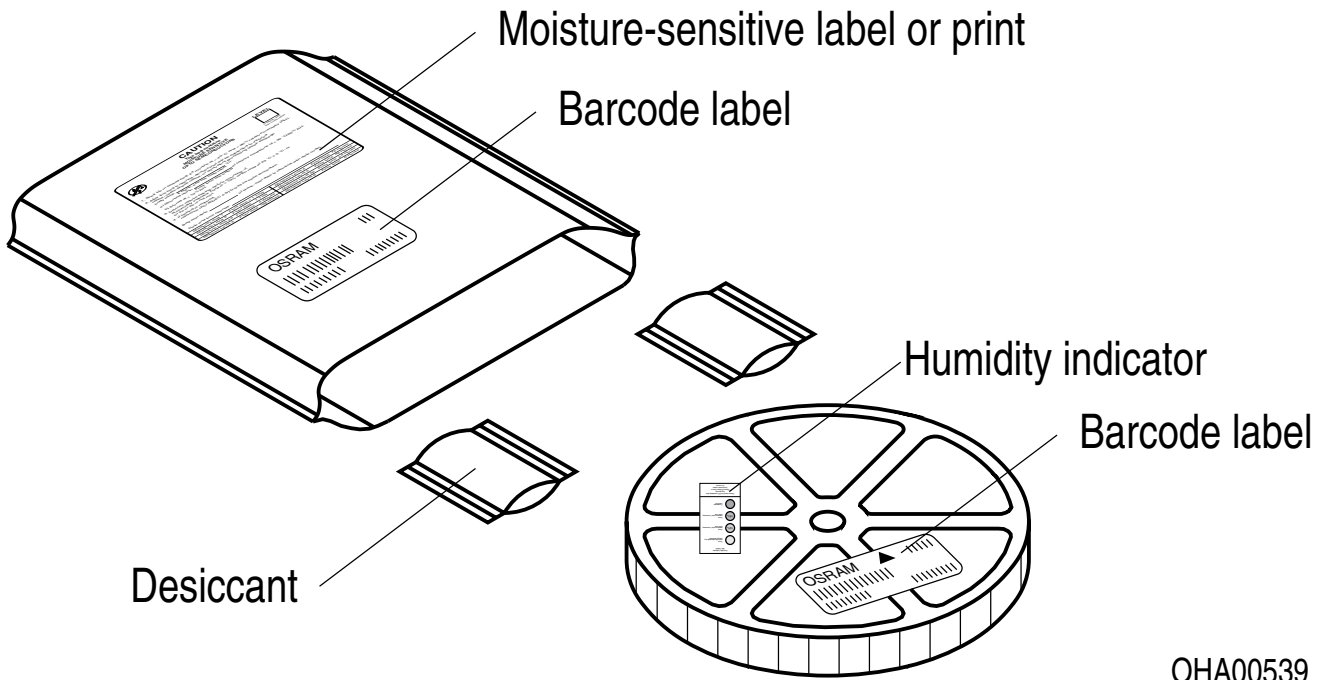

Moisture-sensitive product is packed in a dry bag containing desiccant and a humidity card according JEDEC-STD-033.

Notes

The evaluation of eye safety occurs according to the standard IEC 62471:2006 (photo biological safety of lamps and lamp systems). Within the risk grouping system of this IEC standard, the device specified in this data sheet fall into the class **exempt group (exposure time 10000 s)**. Under real circumstances (for exposure time, conditions of the eye pupils, observation distance), it is assumed that no endangerment to the eye exists from these devices. As a matter of principle, however, it should be mentioned that intense light sources have a high secondary exposure potential due to their blinding effect. When looking at bright light sources (e.g. headlights), temporary reduction in visual acuity and afterimages can occur, leading to irritation, annoyance, visual impairment, and even accidents, depending on the situation.

Subcomponents of this device contain, in addition to other substances, metal filled materials including silver. Metal filled materials can be affected by environments that contain traces of aggressive substances. Therefore, we recommend that customers minimize device exposure to aggressive substances during storage, production, and use. Devices that showed visible discoloration when tested using the described tests above did show no performance deviations within failure limits during the stated test duration. Respective failure limits are described in the IEC60810.

For further application related information please visit www.osram-os.com/appnotes

Disclaimer

Attention please!

The information describes the type of component and shall not be considered as assured characteristics. Terms of delivery and rights to change design reserved. Due to technical requirements components may contain dangerous substances.

For information on the types in question please contact our Sales Organization.

If printed or downloaded, please find the latest version on our website.

Packing

Please use the recycling operators known to you. We can also help you – get in touch with your nearest sales office. By agreement we will take packing material back, if it is sorted. You must bear the costs of transport. For packing material that is returned to us unsorted or which we are not obliged to accept, we shall have to invoice you for any costs incurred.

Product and functional safety devices/applications or medical devices/applications

Our components are not developed, constructed or tested for the application as safety relevant component or for the application in medical devices.

Our products are not qualified at module and system level for such application.

In case buyer – or customer supplied by buyer – considers using our components in product safety devices/ applications or medical devices/applications, buyer and/or customer has to inform our local sales partner immediately and we and buyer and /or customer will analyze and coordinate the customer-specific request between us and buyer and/or customer.

Glossary

- 1) **Radiant intensity:** Measured at a solid angle of $\Omega = 0.01$ sr
- 2) **Brightness:** The brightness values are measured with a tolerance of $\pm 11\%$.
- 3) **Reverse Operation:** This product is intended to be operated applying a forward current within the specified range. Applying any continuous reverse bias or forward bias below the voltage range of light emission shall be avoided because it may cause migration which can change the electro-optical characteristics or damage the LED.
- 4) **Wavelength:** The wavelengths are measured with a tolerance of ± 1 nm.
- 5) **Forward Voltage:** The forward voltages are measured with a tolerance of ± 0.1 V.
- 6) **Total radiant flux:** Measured with integrating sphere.
- 7) **Thermal resistance:** junction - soldering point, of the device only, mounted on an ideal heatsink (e.g. metal block)
- 8) **Typical Values:** Due to the special conditions of the manufacturing processes of semiconductor devices, the typical data or calculated correlations of technical parameters can only reflect statistical figures. These do not necessarily correspond to the actual parameters of each single product, which could differ from the typical data and calculated correlations or the typical characteristic line. If requested, e.g. because of technical improvements, these typ. data will be changed without any further notice.
- 9) **Testing temperature:** TS = 25°C (unless otherwise specified)
- 10) **Tolerance of Measure:** Unless otherwise noted in drawing, tolerances are specified with ± 0.1 and dimensions are specified in mm.
- 11) **Tape and Reel:** All dimensions and tolerances are specified acc. IEC 60286-3 and specified in mm.

Revision History

Version	Date	Change
1.0	2022-06-09	Initial Version



EU RoHS and China RoHS compliant product

此产品符合欧盟 RoHS 指令的要求；
按照中国的相关法规和标准，
不含有毒有害物质或元素。

Published by ams-OSRAM AG

Tobelbader Strasse 30, 8141 Premstaetten, Austria

Phone +43 3136 500-0

ams-osram.com

© All rights reserved

am 

OSRAM

Mouser Electronics

Authorized Distributor

Click to View Pricing, Inventory, Delivery & Lifecycle Information:

[ams OSRAM:](#)

[SFH 7017](#)